

# FlexHammer™ FH1500 Mobile

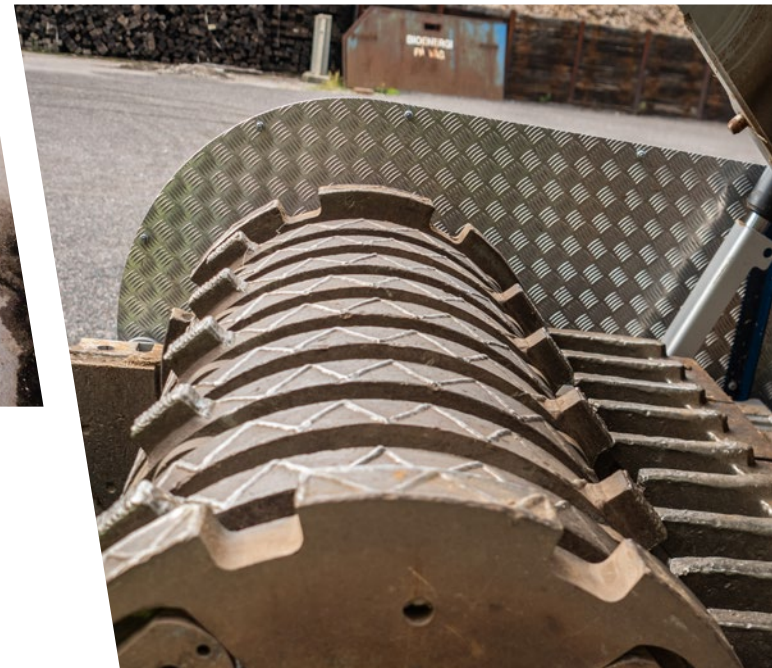

## The ultimate mobile FlexHammer™ unit

- » Outstanding performance with 35 years of built-in experience.
- » The FlexHammer™ system combines outstanding performance with mobility.
- » Swedish quality.



Solutions for industrial recycling

## Solutions in waste handling

# IQR FlexHammer™ 1500 Mobile Unit

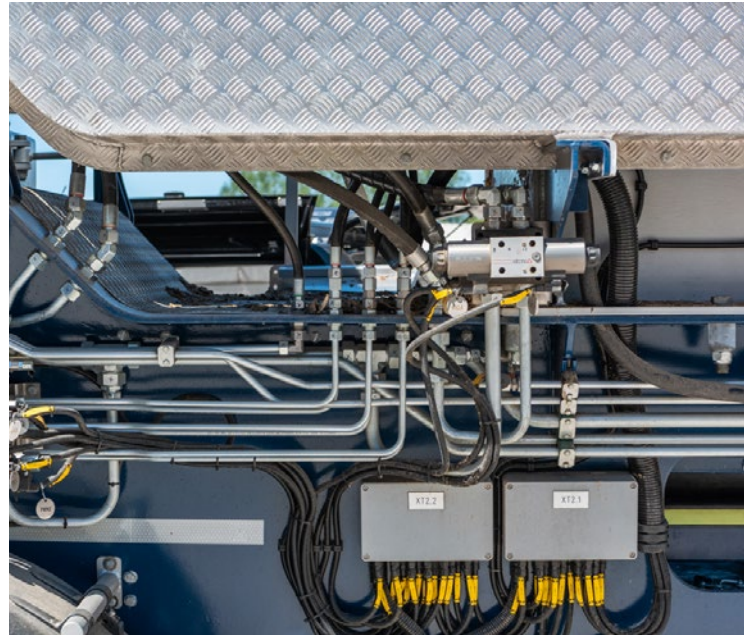

# WELL KNOWN FOR IT'S UNBEATEN CAPACITY AND FLEXIBILITY.

The FH1500 Mobile Unit is a well known all purpose, heavy duty, high capacity hammermill of industrial quality standard.

## Typical feed materials:

- » Wood waste e.g. demolition timber, railway sleepers, treetops and branches, bark, offcuts from industries etc.
- » Household waste.
- » Industrial waste of different kinds.
- » Commercial waste, packing materials.

## Finished products:

Are being used as fuel for energy production or for compost or just for volume reduction.

## Particle size of finished products:

The hammermill's design allows for a large variety of the finished products' particle size. Typical finished products are e.g. between 0-50, 0-100 and 0-250 mm.

## Contaminations:

The hammermill has a mechanical safety device in form of a reject door which opens in case of pressure from uncrushable objects. Stones will be crushed.

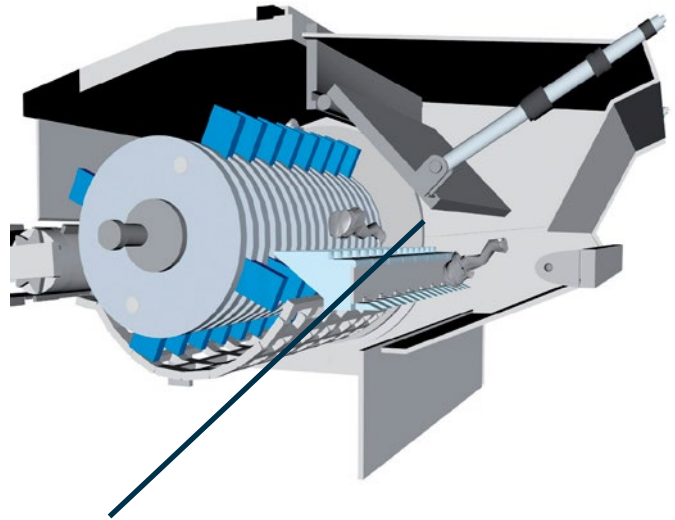

### *FlexRejectDoor™*

*This is a safety device which protects the mill from damage and stoppages if any uncrushable material is fed in by mistake.*

## DATA

Dimensions transport L/W/H:	12,40 (11,5 King-pin) / 2,55 / 4,30 m
Total weight:	~35 ton
Feed opening dimensions, width / height:	1,5 m / 0,8 m
Feedroller diameter:	0,8 m
Feeder:	4,5 / 1,5 (6m3)
Rotor weight:	~4 tons
No. of hammers / Weight of hammer:	48 pcs / 11kg
Rotor diameter/tip to tip:	1200 mm
Rotor speed:	~880 rpm
Engine:	Scania DC16 Stage 5
Engine power:	670 - 770hp (1025hp)
Magnet type:	Elme permanent cross belt magnet
End magnet in drive drum:	Yes
Discharge belt width:	1,2 m
Discharge belt - dropping height:	4,5 m





Solutions for industrial recycling

## Headquarter, Trollhättan

### Postal and delivery address

---

IQR Systems AB  
Stallbackavägen 26  
461 38 Trollhättan  
Sweden

### Phone & E-mail

---





Office: +46 520-48 58 80  
info@iqr.se

## Online

### Webb & social media

---

[www.iqr.se](http://www.iqr.se)

 @IQRsystems  
 @IQRsystems  
 IQRsystems  
 IQRsystems